

Mettec 19"

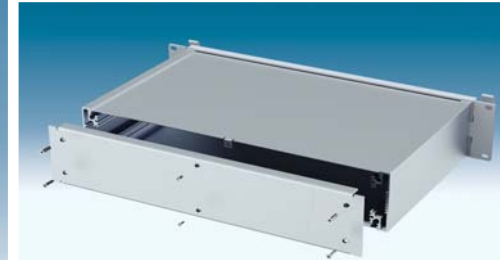
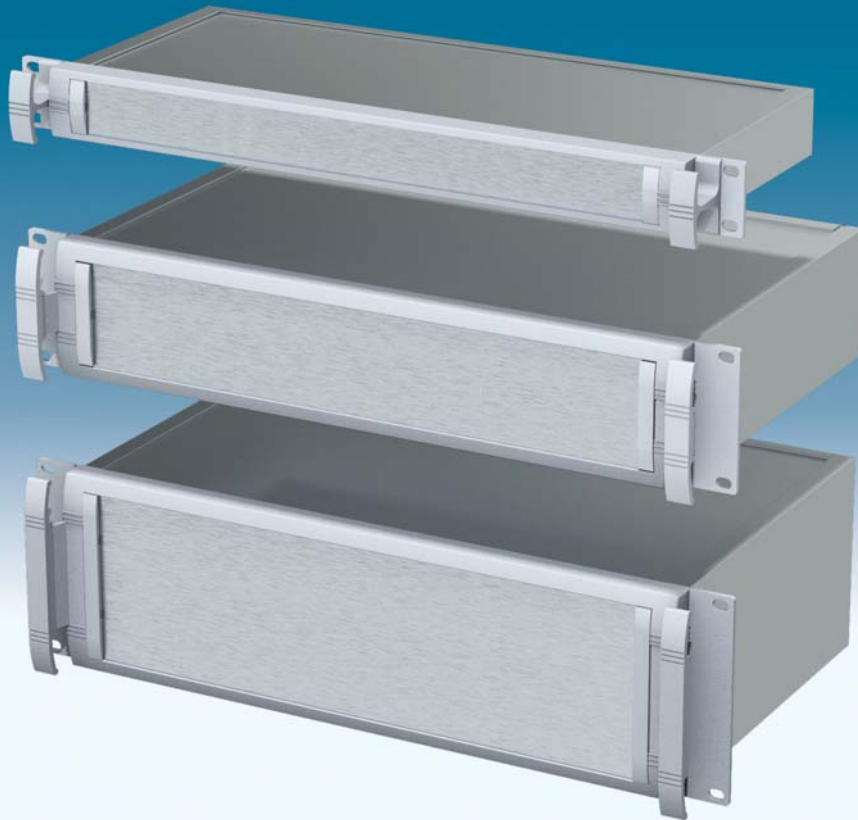

Mettec 19" Rack Mount Cases

Exclusive range of 19" rack cases in aluminium. Conforms to DIN 41494 & IEC 297-1. Heights: 1U, 2U and 3U in three standard depths. Attractive die cast front bezel incorporating unique 'comfort-handles' and rack mounting ears. Robust case body assembly includes flat top and base panels, two side extrusions and the rear panel. Internal guide rails for PCBs and chassis plates. Front panel (accessory) recessed in bezel for locating keypads or labels. Order your own fully customised version.

Mettec 19" Rack-Gehäuse

Exklusives Sortiment von 19" Rack-Gehäusen aus Aluminium. Entspricht DIN 41494 und IEC 297-1. Höhen: 1HE, 2HE und 3HE in drei Standardtiefen. Attraktiver Druckguss-Frontrahmen mit einzigartigen „Komfortgriffen“ und Rack-Montagelassen. Robuste Gehäusekorpus-Baugruppe mit flacher Deck- und Bodenplatte, zwei Seitenprofilen und der Rückwand. Führungen innen für Leiterkarten und Trägerplatten. Vertieft in Rahmen liegende Frontplatte (Zubehör). Bestellen Sie Ihre eigene kundenspezifische Version.

Boitiers Mettec pour rack 19"

Gamme exclusive de boitiers pour rack 19" en aluminium. Conforme aux normes DIN 41494 et IEC 297-1. Hauteurs : 1U, 2U et 3U en trois profondeurs. Élégant cadre frontal moulé sous pression incorporant des « poignées de confort » inédites et des oreilles de montage en rack. Le corps robuste du boitier comprend des plaques supérieure et inférieure plates, deux extrusions latérales et la plaque arrière. Plaque avant (accessoire) encastrée dans le cadre. Commandez votre version entièrement personnalisée.

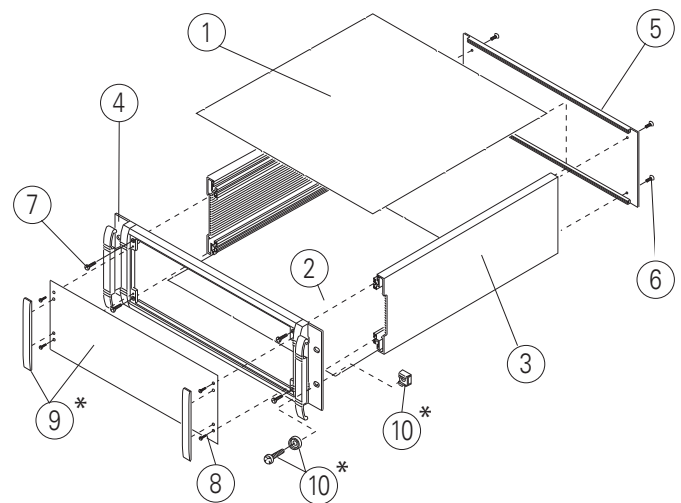

Supply

- ① Top cover
- ② Base panel
- ③ Side extrusion (x2)
- ④ 19" front bezel
- ⑤ Rear panel
- ⑥ M4 x 16 mm (x2/4)
- ⑦ M4 x 16 mm (x2/4)
- ⑧ M3 x 8 mm (x4)
- ⑨ *Front panel kit
- ⑩ *19" Mounting kit

* Accessories

Lieferumfang

- Deckplatte
- Bodenplatte
- Seitenprofil (x2)
- 19" Frontrahmen
- Rückplatte
- M4 x 16 mm (x2/4)
- M4 x 16 mm (x2/4)
- M3 x 8 mm (x4)
- *Frontplatten-Set
- *19"-Montage-Set

* Zubehör

Fourniture

- Plaque supérieur
- Plaque inférieure
- Profil latéral extrudé (x2)
- Cadre frontal 19"
- Plaque arrière
- M4 x 16 mm (x2/4)
- M4 x 16 mm (x2/4)
- M3 x 8 mm (x4)
- *Kit de plaque avant
- *Kit de montage pour châssis 19"

* Accessoires



Standard colours
Standardfarben
Coloris standard

Mettec 19"

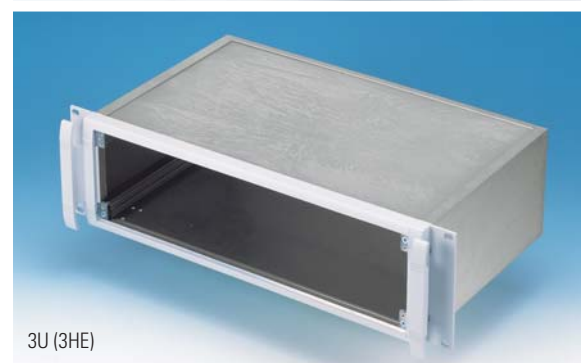
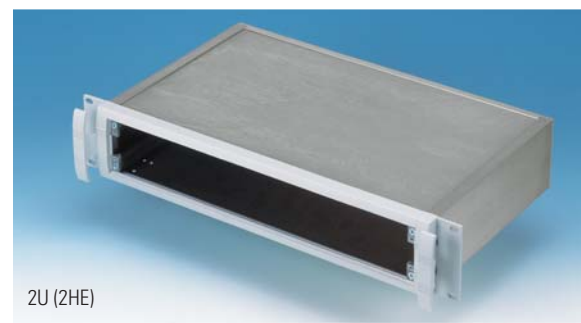
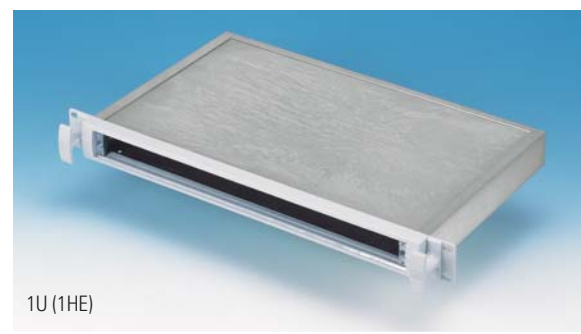
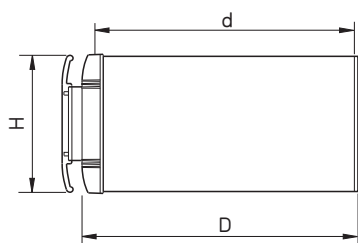
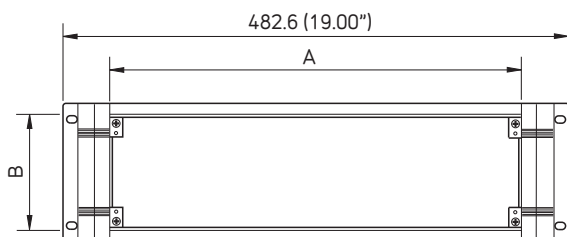

Part No. Bestell-Nr./Réf.	H	D	d	A Front Panel Frontplatte Plaque avant	B Front Panel Frontplatte Plaque avant
M 59 10 015	1U (1HE)	167.5 (6.59")	158.8 (6.25")	392.5 (15.45")	33.6 (1.32")
M 59 10 025	1U (1HE)	267.5 (10.35")	258.8 (10.18")	392.5 (15.45")	33.6 (1.32")
M 59 10 035	1U (1HE)	367.5 (14.46")	358.8 (14.12")	392.5 (15.45")	33.6 (1.32")
M 59 20 015	2U (2HE)	167.5 (6.59")	158.8 (6.25")	392.5 (15.45")	67.1 (2.64")
M 59 20 025	2U (2HE)	267.5 (10.35")	258.8 (10.18")	392.5 (15.45")	67.1 (2.64")
M 59 20 035	2U (2HE)	367.5 (14.46")	358.8 (14.12")	392.5 (15.45")	67.1 (2.64")
M 59 30 015	3U (3HE)	167.5 (6.59")	158.8 (6.25")	392.5 (15.45")	111 (4.37")
M 59 20 025	3U (3HE)	267.5 (10.35")	258.8 (10.18")	392.5 (15.45")	111 (4.37")
M 59 20 035	3U (3HE)	367.5 (14.46")	358.8 (14.12")	392.5 (15.45")	111 (4.37")

Front Panel Kit

Frontplatten-Set
Kit de plaque avant

Part No. Bestell-Nr./Réf.	Version	A	B
M 59 00 010	1U (1HE)	33.6 (1.32")	22.1 (0.87")
M 59 00 020	2U (2HE)	67.1 (2.64")	32.5 (1.27")
M 59 00 030	3U (3HE)	111.0 (4.37")	77.0 (3.03")

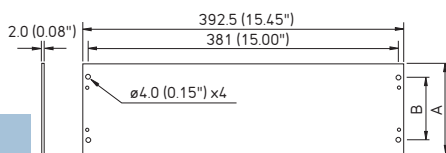

Chassis Plate

Montageplatte
Plaque support

Part No. Bestell-Nr./Réf.	Version	A
M 59 00 201	167.5 (6.59")	149 (5.86")
M 59 00 202	267.5 (10.35")	249 (9.80")
M 59 00 203	367.5 (14.46")	349 (13.74")

